

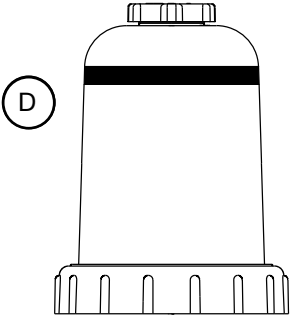



SERVICE PARTS AND KITS		
A	102425DAV	Collar
B	240023DAV	Vent Cap Service Kit Vent Cap and Vent Cap O-ring
C	103100DAV	Cover, Collar, Spring, Vent Cap and Vent Cap O-ring (Collar o-ring not included)
D	103101DAV	Cover with Black Band, Collar, Spring, Vent Cap and Vent Cap O-ring (Collar o-ring not included)
		
E	380072DAV	O-ring Service Kit
F	380056DAV	Spring
G	101132DAV	Check Valve Service Kit (Includes Ball, Spring, and Retainer)
		
H	103071DAV	Check Valve Assembly (Includes Body and Check Valve Service Kit)
		
I	102008DAV	Drain Valve (Threads: 1/2"-14 NPT)
J	380134DAV	Collar Wrench
		

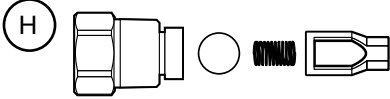
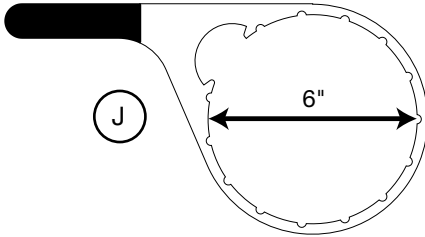
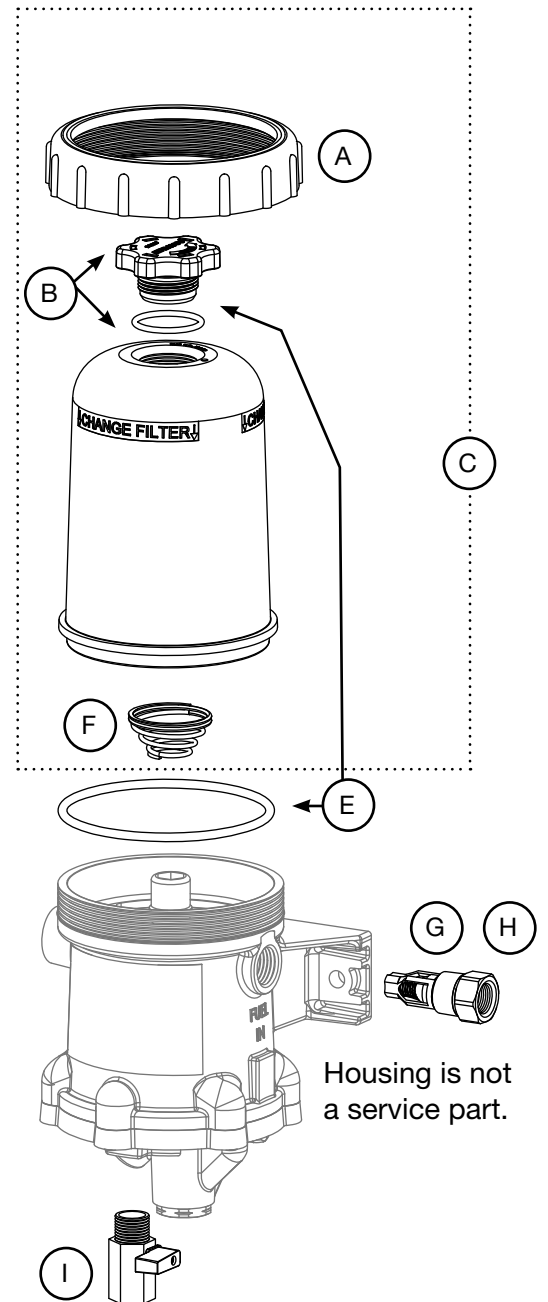
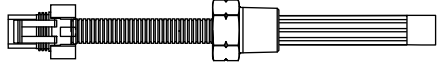
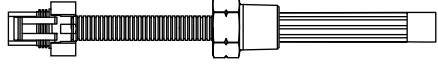
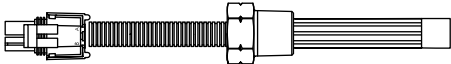
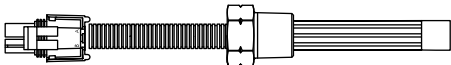
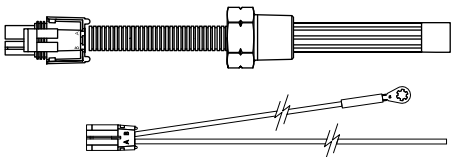

PRE-HEATER PARTS		
103528DAV	12VDC 195W PTC Pre-heater, Metri-Pack Connector, ½"-14 NPTF Threads, Harness Length 19.81"	
103594DAV	12VDC 155W PTC Pre-heater, Metri-Pack Connector, ½"-14 NPTF Threads, Harness Length 24.50"	
103529DAV	12VDC 195W PTC Pre-heater, Weather Pack Connector, ½"-14 NPTF Threads, Harness Length 19.81"	
102692DAV	Kit includes: 24VDC 195W PTC Pre-heater (103539), Weather Pack Connector, ½"-14 NPTF Threads, Harness Length 19.81", seals, and plug	
102691DAV	Kit includes: 12VDC 195W PTC Pre-heater (103529), Weather Pack Connector, ½"-14 NPTF Threads, Harness Length 19.31", Seals, Plug, Wiring harness (102220), and Clamp	
102376DAV	Heater Chassis Harness, Metri-Pack Connector	
102220DAV	Heater Chassis Harness, Weather Pack Connector	

*Note: Visit www.davco.com, Form F1263 for 12VDC and 24VDC pre-heater part numbers for pre-heaters installed prior to 2007. For Specific OEM numbers for pre-heaters, contact customer support at 1-800-328-2611.

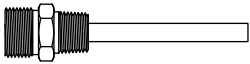
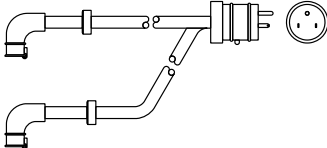
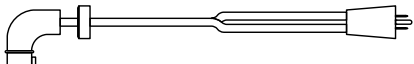
OVERNIGHT HEATER PARTS		
102145DAV	120VAC 75W Overnight Heater, ½"-14 NPTF Threads	
102015DAV	120VAC Overnight Heater "Y" Cord	
101868DAV	120VAC Overnight Heater Straight Cord	

WATER-IN-FUEL (WIF) SENSOR PARTS		
102512DAV	Two Pin WIF, Deutsch Connector (black), 1/2"-20 UNF Threads, Harness Length 3.36"	
102521DAV	Two Pin WIF, Deutsch Connector (black), 1/2"-20 UNF Threads, Harness Length 3.36"	
101017PAC	One Pin WIF, 1/8"-27 NPTF Thread	
102507DAV	Two Pin WIF, M14-2 Threads with Seal (Fleetguard and Bus Applications)	
102519DAV	Two Pin WIF, Metri-Pack Connector, 1/2"-20 UNF Threads, Harness 17.5" (Freightliner)	
102770DAV	Two Pin WIF, Metri-Pack Connector, 1/2"-20 UNF Threads, Harness Length 6.50" (Freightliner)	
102871DAV	Two Pin WIF, Tyco/AMP Connector, 1/2"-20 UNF Threads, Harness Length 3.25" (Navistar)	
103111DAV	Two Pin WIF, Tyco/AMP Connector, 1/2"-20 UNF Threads, Harness Length 3.25" (Paccar)	
102600DAV	Two Pin WIF Wiring Harness (Used with 102512 and 102521DAV)	

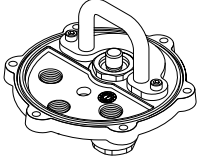
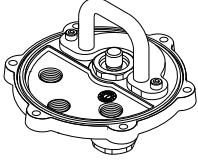
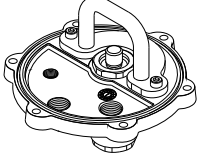
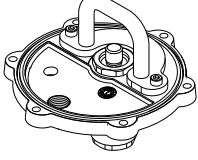
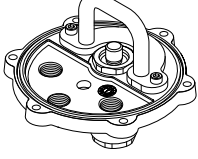
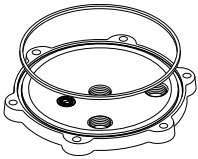
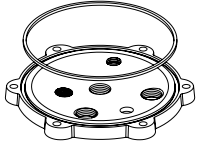
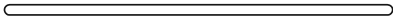
BOTTOM PLATES		
382029-23DAV	"Universal" (All Ports are machined.) Coolant Heat Ports (2), Threads: 3/8"-18 NPTF Pre-heater Ports (2), Threads: 1/2"-14 NPTF, plugs supplied WIF Port, Threads: 1/2"-20 UNF, plug supplied Drain Port, Threads: 1/2"-14 NPT (drain valve not supplied) 6 bolts, 1 square cut seal	
382029SVCB	Coolant Heat Ports (2), Threads: 3/8"-18 NPTF Pre-heater Ports (2), Threads: 1/2"-14 NPTF, plugs supplied Drain Port, Threads: 1/2"-14 NPT (drain valve not supplied) 6 bolts, 1 square cut seal	
382029SVCBE	Quick Connect drain fitting, Port, Threads: 1/4" NPTF Pre-heater Ports (2), Threads: 1/2"-14 NPTF, plugs supplied Drain Port, Threads: 1/2"-14 NPT (drain valve not supplied) 6 bolts, 1 square cut seal	
382029-5SDAV	Coolant Heat Ports (2), Threads: 3/8"-18 NPTF WIF Port, Threads: 1/2"-20 UNF, plugs supplied Drain Port, Threads: 1/2"-14 NPT (drain valve not supplied) 6 bolts, 1 square cut seal	
382029NAV	(Navistar Bottom Plate application) Coolant Heat Ports, (2) Threads: 3/16"-18 NPTF Pre-heater Ports (2), Threads: 1/2"-14 NPTF, plugs supplied WIF Port, Threads: 1/2"-20 UNF, plug supplied Drain Port, Threads: 1/2"-14 NPT (drain valve not supplied) 6 bolts, 1 square cut seal	
Unheated Bottom Plate (Bolt-On)		
382027SVCB	Pre-heater Ports (2), Threads: 1/2"-14 NPTF, plugs supplied Drain Port, Threads: 1/2"-14 NPT (drain valve not supplied) 6 bolts, 1 square cut seal	
382027-28DAV	Pre-heater Ports (2), Threads: 1/2"-14 NPTF, plugs supplied WIF Port, Threads: 1/2"-20 UNF, plug supplied, WIF Port, Threads: M14, plug supplied, Drain Port, Threads: 1/2"-14 NPT (Drain valve not supplied) 6 bolts, 1 square cut seal	
BOTTOM PLATE SEALS		
101994DAV	Seal, round, bottom collar	
910005DAV	Seal, square cut, bolt on	