

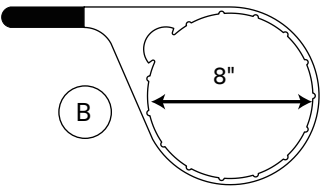

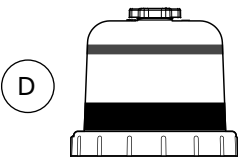

P/N		DESCRIPTION
A	240023DAV	Vent Cap Service Kit
B	482017DAV	Collar Wrench
		
C	482044DAV	Cover, Collar, Spring, Vent Cap and Vent Cap O-ring
D	482046DAV	Cover with Black Band, Collar, Spring, Vent Cap and Vent Cap O-ring (Collar o-ring not included)
		
E	482003DAV	Collar
F	380056DAV	Filter Spring
G	482022DAV	O-ring Service Kit (Vent Cap/Collar)
H	102145DAV	120VAC Overnight Heater
I	103071DAV	Check Valve Assembly (ball, spring, retainer and body)
		
	101132DAV	Check Valve Service Kit (Ball, spring and retainer)
		
J	020909DAV	Plug
K	103529DAV	12VDC 195W PTC Pre-heater-see next page
L	DVC 485022DAV	Quick Connect Drain Valve - Includes: valve body, retaining ring (M), both seals (N), and protective cap (O)
M	485025DAV	Retaining Ring
N	485021DAV	Drain Valve Seal Service Kit
O	102712DAV	Drain Valve Dust Cap
P	102871DAV	WIF
FILTERS (AVAILABLE THROUGH OEM DISTRIBUTORS)		
FS20083	Fleetguard	

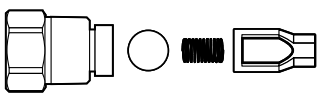

FOR UPDATED INFORMATION, VISIT WWW.DAVCO.COM

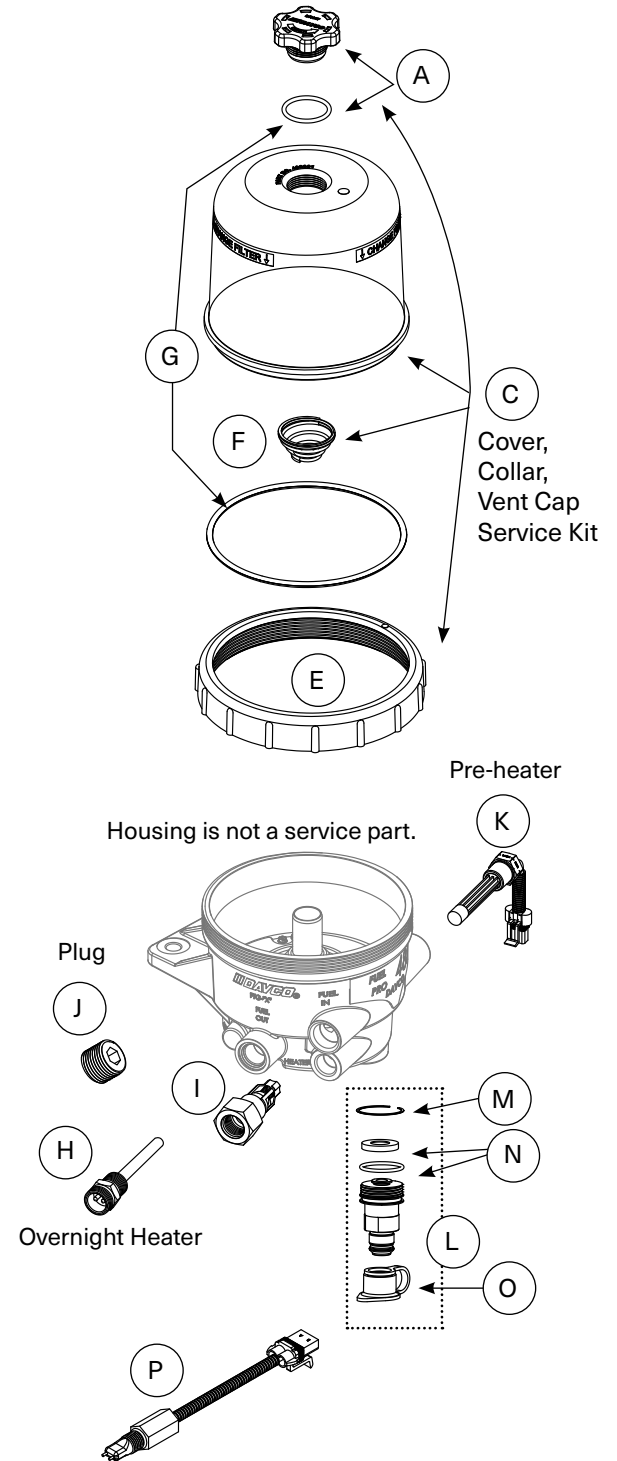
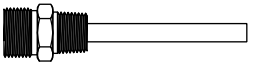
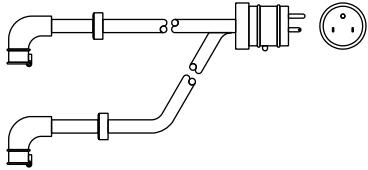
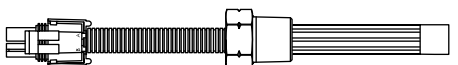
OVERNIGHT HEATER PARTS		
102145DAV	120VAC 75W Overnight Heater, ½"-14 Threads	
102015DAV	120VAC Overnight Heater "Y" Cord	
101868DAV	120VAC Overnight Heater Straight Cord	
PRE-HEATER		
103529DAV	12VDC 195W PTC Pre-heater, Weather Pack Connector, ½"-14 NPTF Threads, Harness Length 19.81"	
WATER-IN-FUEL (WIF) SENSOR		
102871DAV	Two Pin WIF, Tyco/AMP Connector, ½"-20 UNF Threads, ½" Harness Length 3.25" (Navistar)	