

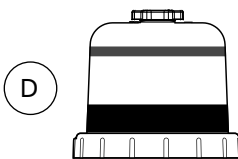







SERVICE PARTS AND KITS		
A	482003SDAV	Collar
B	240023DAV	Vent Cap Service Kit (vent cap and o-ring)
C	483047SDAV	Cover, Collar, Spring, Vent Cap and Vent Cap O-ring (Collar o-ring not included)
D	482046DAV	Cover with Black Band, Collar, Spring, Vent Cap and Vent Cap O-ring (Collar o-ring not included)
		
E	482022DAV	O-ring Service Kit (Vent Cap/Collar)
F	380056DAV	Spring
G	101132DAV	Check Valve Service Kit (Includes Ball, Spring, and Retainer)
		
H	482012DAV	Check Valve Assembly (Includes Body and Check Valve Service Kit)
		
	103209PAC	Voss Check Valve Assembly (for PACCAR 2017 and new only)
		
I	102008DAV	Drain Valve
J	482017DAV	Collar Wrench
		
K	483029DAV	Therموالve
L	020909	Coolant Port Plug (4 per kit)
M	101999DAV	Therموالve Port Cap
N	103603DAV	Combination Drain Kit (Includes drain, dust cap and plug for use on units with cover with black band. Part number for unit contains an "E". Replaces ESOC fitting 102844, except on Freightliner Trucks.)

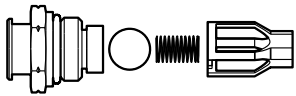
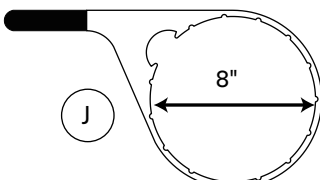
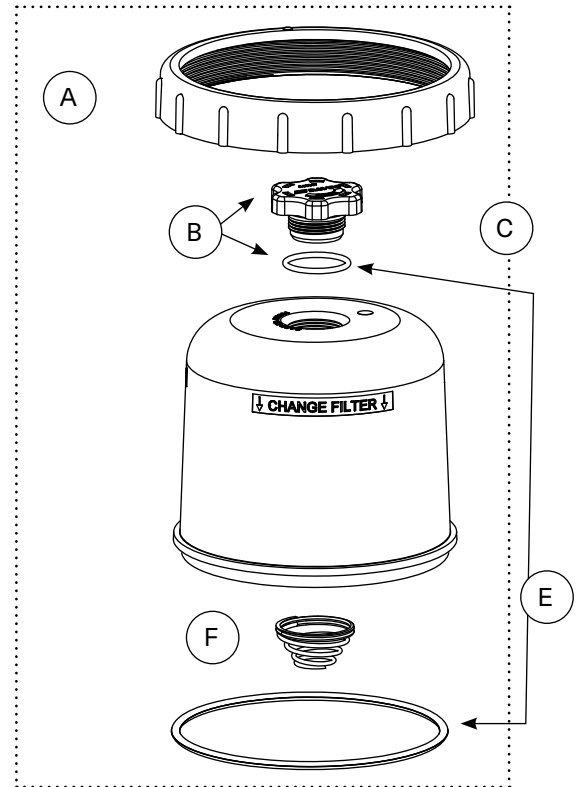
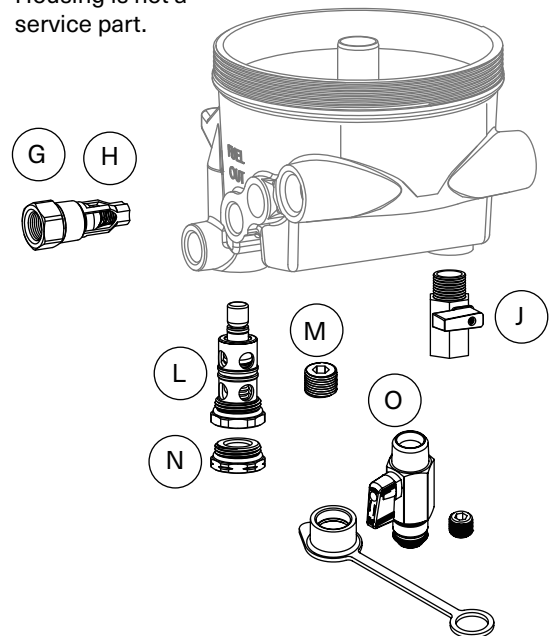

Housing is not a service part.

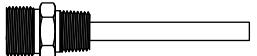
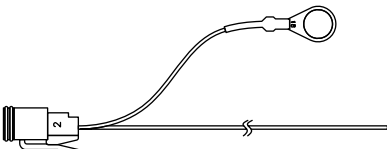
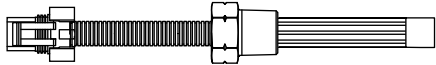

HEATERS AND WATER-IN-FUEL (WIF) SENSORS		
102512DAV	Two Pin WIF, Deutsch Connector (gray), ½"-20 UNF Threads, Harness Length 3.36"	
102521DAV	Two Pin WIF, Deutsch Connector (black), ½"-20 UNF Threads, Harness Length 3.36"	
102770DAV	Two Pin WIF, Metri-Pack Connector, ½"-20 UNF Threads, Harness Length 6.50"	
102871DAV	Two Pin WIF, Tyco/AMP Connector, ½"-20 UNF Threads, Harness Length 3.25" (Navistar)	
103111DAV	Two Pin WIF, Tyco/AMP Connector, ½"-20 UNF Threads, Harness Length 3.25" (Paccar)	
103138PAC	Two Pin WIF, Tyco/AMP Connector, ½"-20 UNF Threads, Harness Length 10.50" (Paccar)	
102145DAV	120VAC 75W Overnight Heater, ½"-14 Threads	
102600DAV	Two Pin WIF Wiring Harness (Used with 102512 and 102521DAV) Deutsch Connector	
103528DAV	12VDC 195W PTC Pre-heater, Metri-Pack Connector, ½"-14 NPTF Threads, Harness Length 19.81"	
103529DAV	12VDC 195W PTC Pre-heater, Weather Pack Connector, ½"-14 NPTF Threads, Harness Length 19.81"	